





Index

FULL IP system installation guide	4
Preliminary requirements	4
Procedure	5
Community VLAN network creation	6
Community structure definition	9
Community structure creation	11
Mac address registration	19
Forwarding of the address book to the DES Server	21
Installation of the devices	22
Activation of the devices	24
System test	25

FULL IP system installation guide

Preliminary requirements

- Wired network with active DHCP server and POE Switch, item 375002, correctly installed in the system
- The PC to be used as client must have Legrand.ware installed
- All the devices must be available in the room where the configuration is being completed
- The DES server, item 375001, must be connected to the network and must have a reserved IP address

To assign a reserved IP address within the DHCP server, the MAC address of the device is normally required.

To find the MAC address:

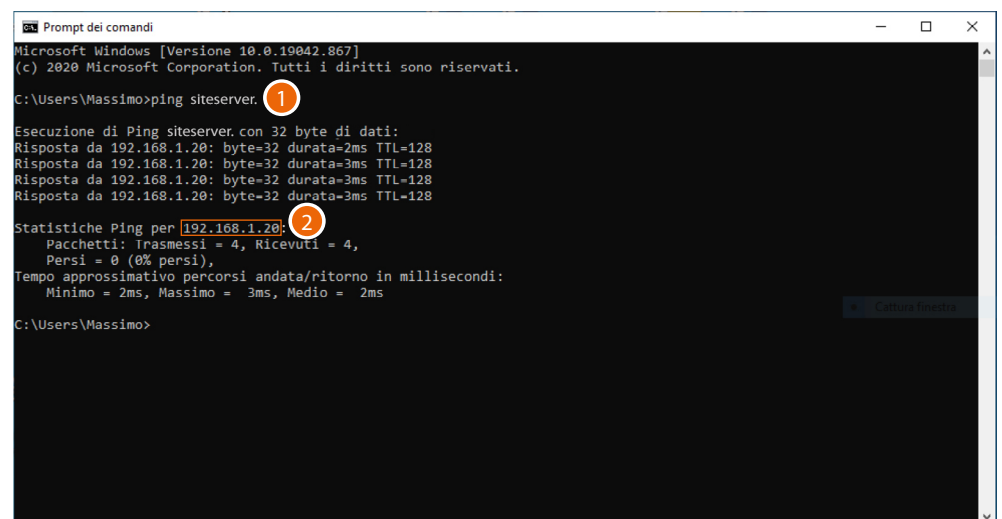

```
Prompt dei comandi
Microsoft Windows [Versione 10.0.19042.867]
(c) 2020 Microsoft Corporation. Tutti i diritti sono riservati.

C:\Users\Massimo>ping siteserver. 1

Esecuzione di Ping siteserver con 32 byte di dati:
Risposta da 192.168.1.20: byte=32 durata=2ms TTL=128
Risposta da 192.168.1.20: byte=32 durata=3ms TTL=128
Risposta da 192.168.1.20: byte=32 durata=3ms TTL=128
Risposta da 192.168.1.20: byte=32 durata=3ms TTL=128

Statistiche Ping per 192.168.1.20: 2
Pacchetti: Trasmessi = 4, Ricevuti = 4,
Persi = 0 (0% persi),
Tempo approssimativo percorsi andata/ritorno in millisecondi:
Minimo = 2ms, Massimo = 3ms, Medio = 2ms

C:\Users\Massimo>
```

1. On the client PC, connected to the same data network as the DES Server, open the DOS prompt and enter: "ping siteserver."
2. Note down the IP address

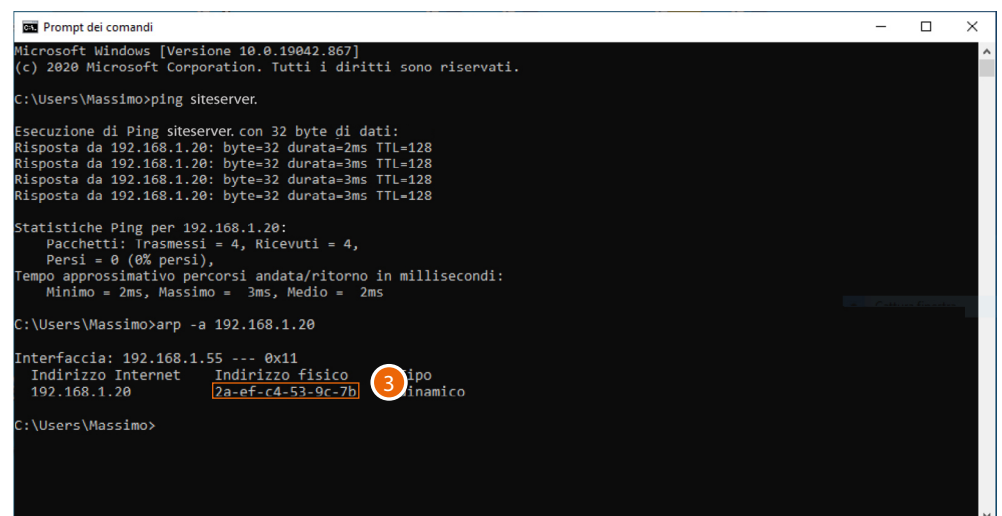

```
Prompt dei comandi
Microsoft Windows [Versione 10.0.19042.867]
(c) 2020 Microsoft Corporation. Tutti i diritti sono riservati.

C:\Users\Massimo>ping siteserver.

Esecuzione di Ping siteserver con 32 byte di dati:
Risposta da 192.168.1.20: byte=32 durata=2ms TTL=128
Risposta da 192.168.1.20: byte=32 durata=3ms TTL=128
Risposta da 192.168.1.20: byte=32 durata=3ms TTL=128
Risposta da 192.168.1.20: byte=32 durata=3ms TTL=128

Statistiche Ping per 192.168.1.20:
Pacchetti: Trasmessi = 4, Ricevuti = 4,
Persi = 0 (0% persi),
Tempo approssimativo percorsi andata/ritorno in millisecondi:
Minimo = 2ms, Massimo = 3ms, Medio = 2ms

C:\Users\Massimo>arp -a 192.168.1.20

Interfaccia: 192.168.1.55 --- 0x11
Indirizzo Internet      Indirizzo fisico      Tipo
192.168.1.20            2a-e4-c4-53-9c-7b   3   dinamico

C:\Users\Massimo>
```

3. Enter: "arp -a 192.168.1.20 (IP address identified in step 2)" to find the MAC address to use to make the IP address reserved

Procedure

To create the system structure and configure the its devices, follow the steps below in progressive order.

Note: *In the example procedure shown below, it is assumed that the on-site configuration is performed using a client PC connected to the same network as the DES Server.*

- Step **01** Community VLAN network creation
- Step **02** Community structure definition
- Step **03** Community structure creation
- Step **04** Device MAC address registration
- Step **05** Forwarding of the address book to the DES Server
- Step **06** Installation of the devices
- Step **07** Activation of the devices
- Step **08** System test

Community VLAN network creation

To configure the community network, configure the system by connecting to the DES Server from a client PC and going to the address: <http://siteserver.local:8081/cms/legrand.html>.

This guide will explain the basic steps.

Before starting on the Client PC, open a browser

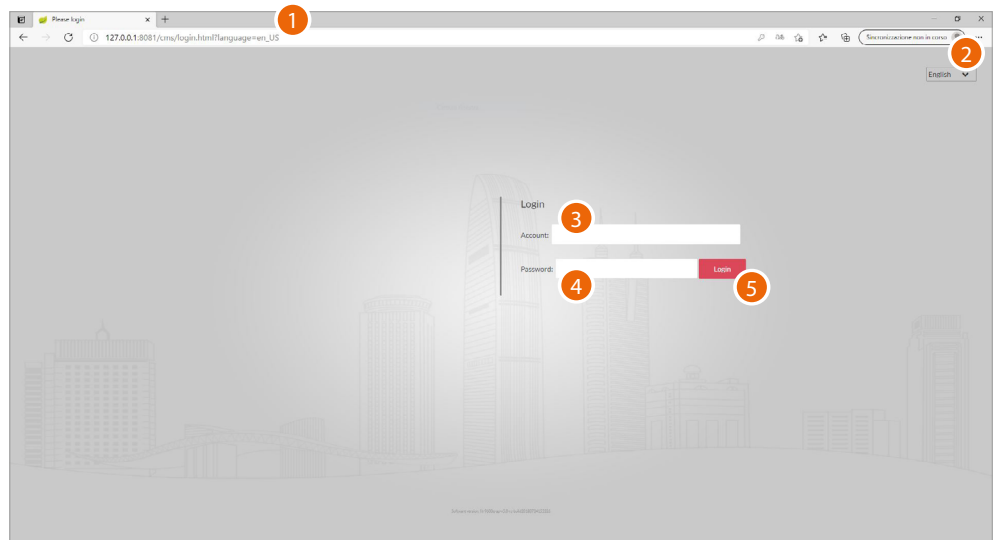

1. Enter the http address of the DES Server:

<http://siteserver.local:8081/cms/legrand.html>

2. Select the interface language.
3. Enter the login name (default admin)
4. Enter the password (default 123456)
5. Click to confirm

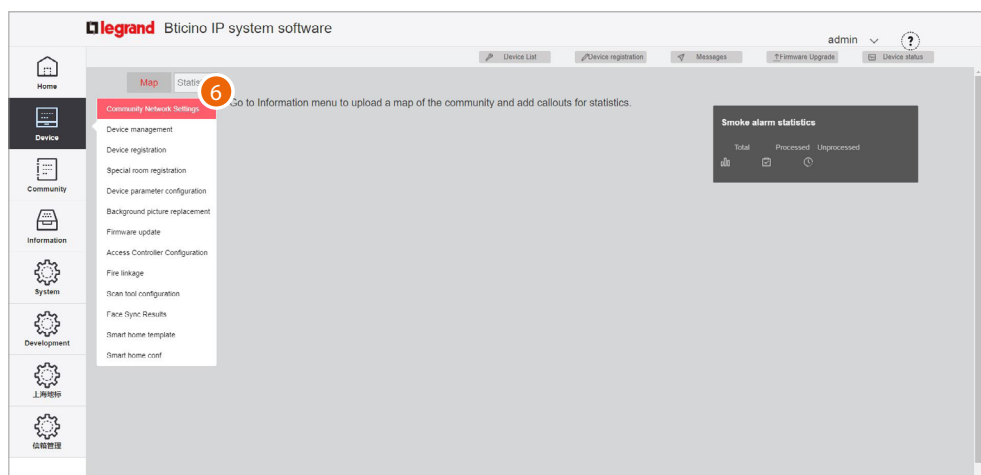

6. Click to open the section where it is possible to create your new community VLAN network

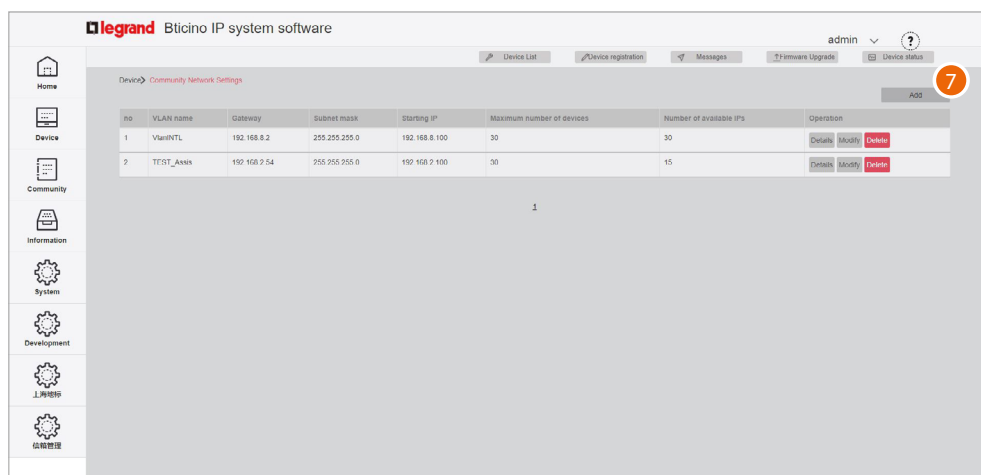

7. Click to create the community VLAN network

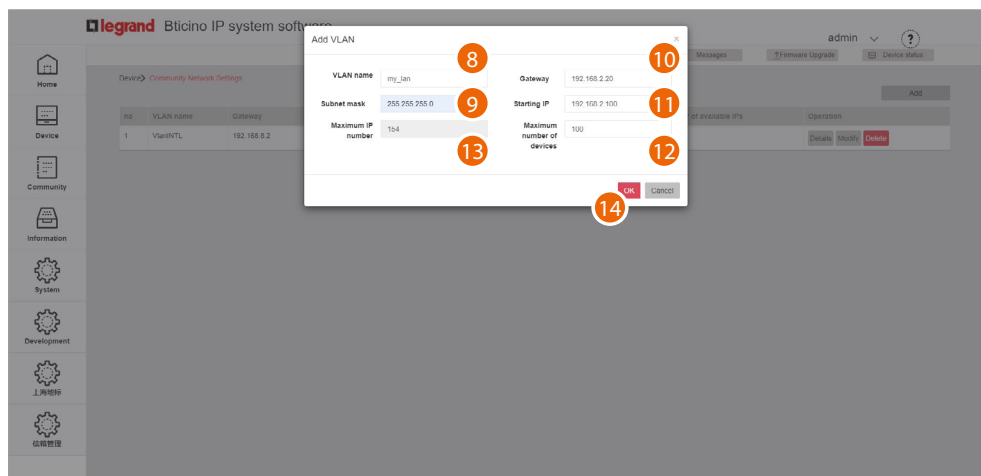

8. Enter the name of the community VLAN network (letters and numbers without space)
9. Enter the Subnet mask address
10. Enter the fixed IP address of the DES Server given to you by the network administrator
11. Enter the starting address from which the IP addresses of the FULL IP devices will be generated
12. Enter the number of FULL IP devices that will be part of the Community
13. It displays the maximum number of FULL IP devices that can be installed based on the previously entered data
14. Click to confirm

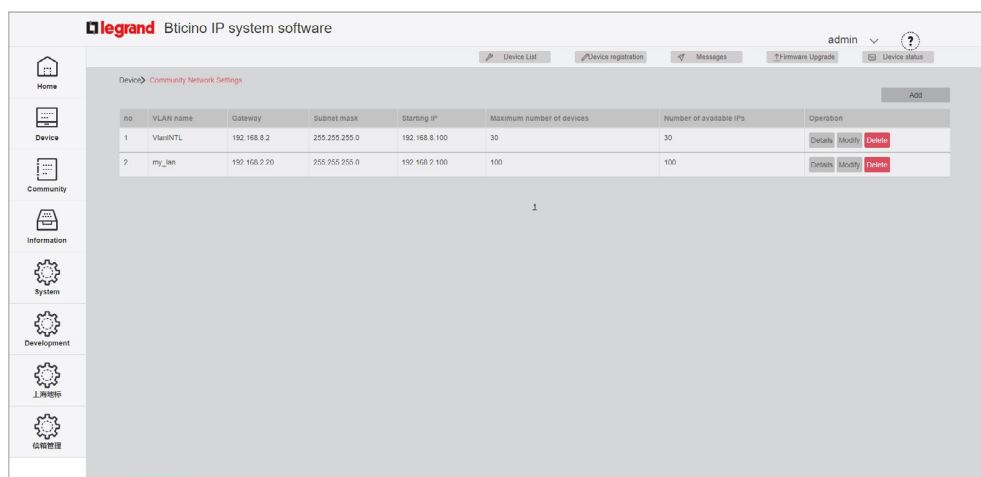

The community VLAN network has been created

Community structure definition

It is now necessary to define parameters like number of Areas, Buildings, Risers and so on, as well as other details that will define the structure of the Community.

In this section, it is also necessary to define the type of call that will be used for all Community calls.

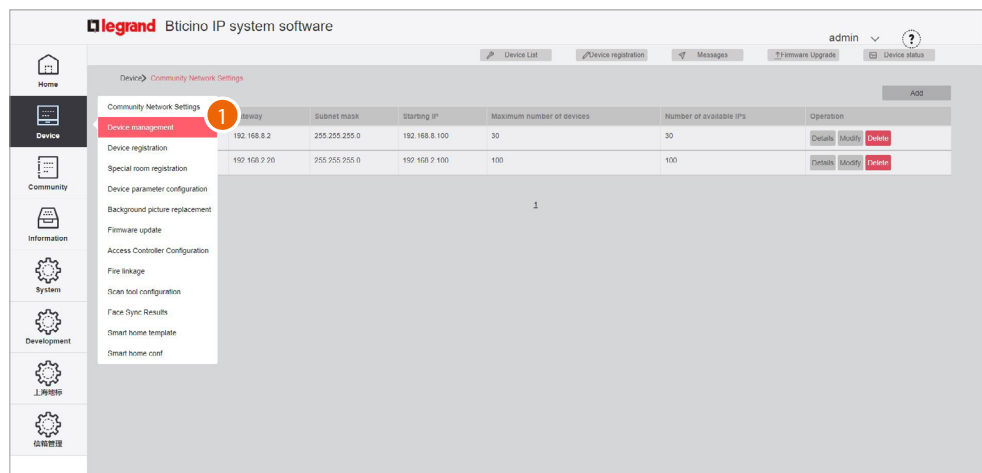

1. Click to enter the Community configuration section

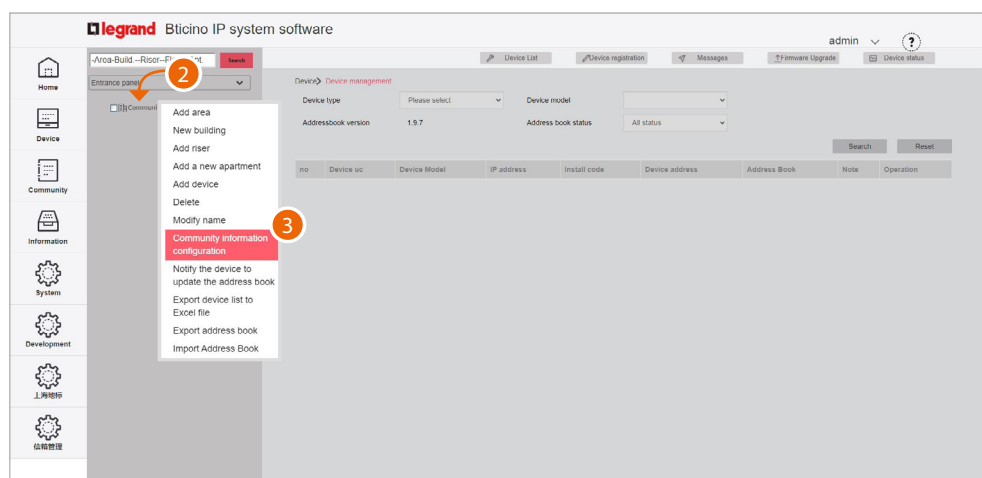

2. Click the Community with the right mouse button: a drop-down menu will appear with the commands for its configuration
3. Click to open the pop-up window with the parameters that define the Community structure

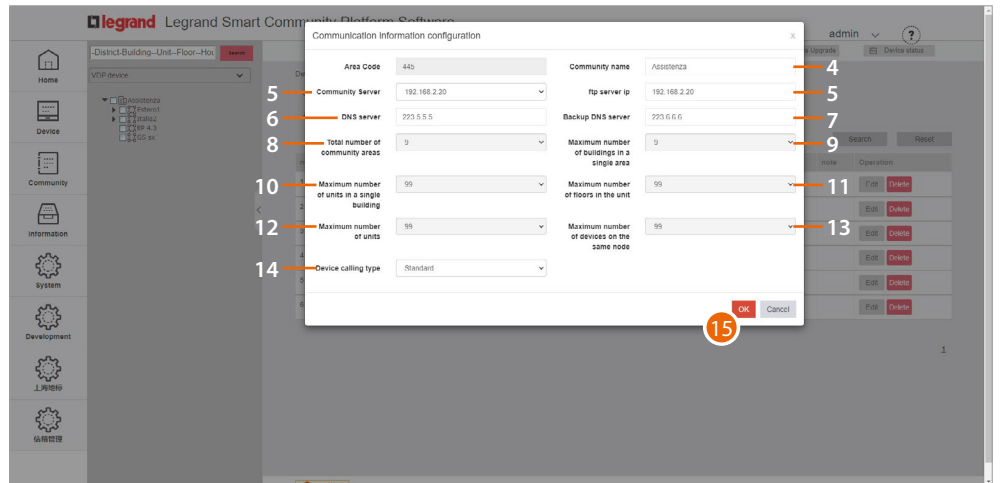

4. Change Community Name
 5. Selects the fixed IP address of the Community DES Server
 6. Change the address of the DNS server (unless there are special requirements, we recommend to keep the default address)
 7. Change the address of the backup DNS server (unless there are special requirements, we recommend to keep the default address)
 8. It displays the maximum number of Areas for your Community (default 9).
 9. It displays the maximum number of Buildings that an Area can have (default 9).
 10. It displays the maximum number of Risers that a Building can have (default 99).
 11. It displays the maximum number of Floors that a Riser can have (default 99).
 12. It displays the maximum number of Apartments that a Floor can have (default 99).
 13. It displays the maximum number of Devices that an Apartment can have (default 99).
- Note:** The default values of item 9 through 14 are consistent with the example shown in this document, and therefore do not need to be changed.
For other more complex structures, see the Software Manual.
14. Selects the type of call to be used for the system: Standard or Alphanumeric.
When selecting Alphanumeric, it will also be necessary to select a mode, "0-9, AZ" or "0-9, AI", depending on the type of EPs installed in the Community.

Note: If even one single EP has an "0-9, AI" type keypad, select the "0-9, AI" option.

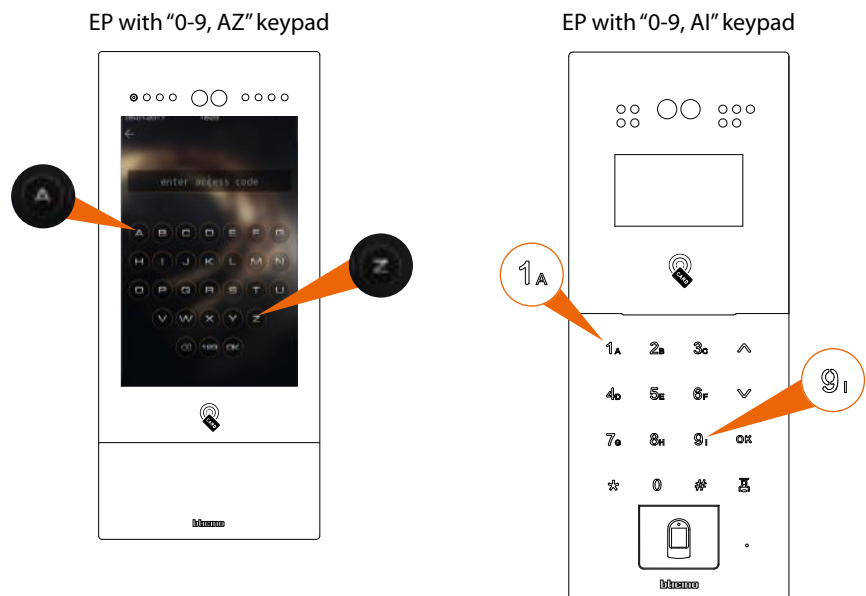

15. Click to confirm

Community structure creation

Depending on how your Community is composed, you will need to hierarchically enter:



This document will show the creation of a sample structure composed as follows:

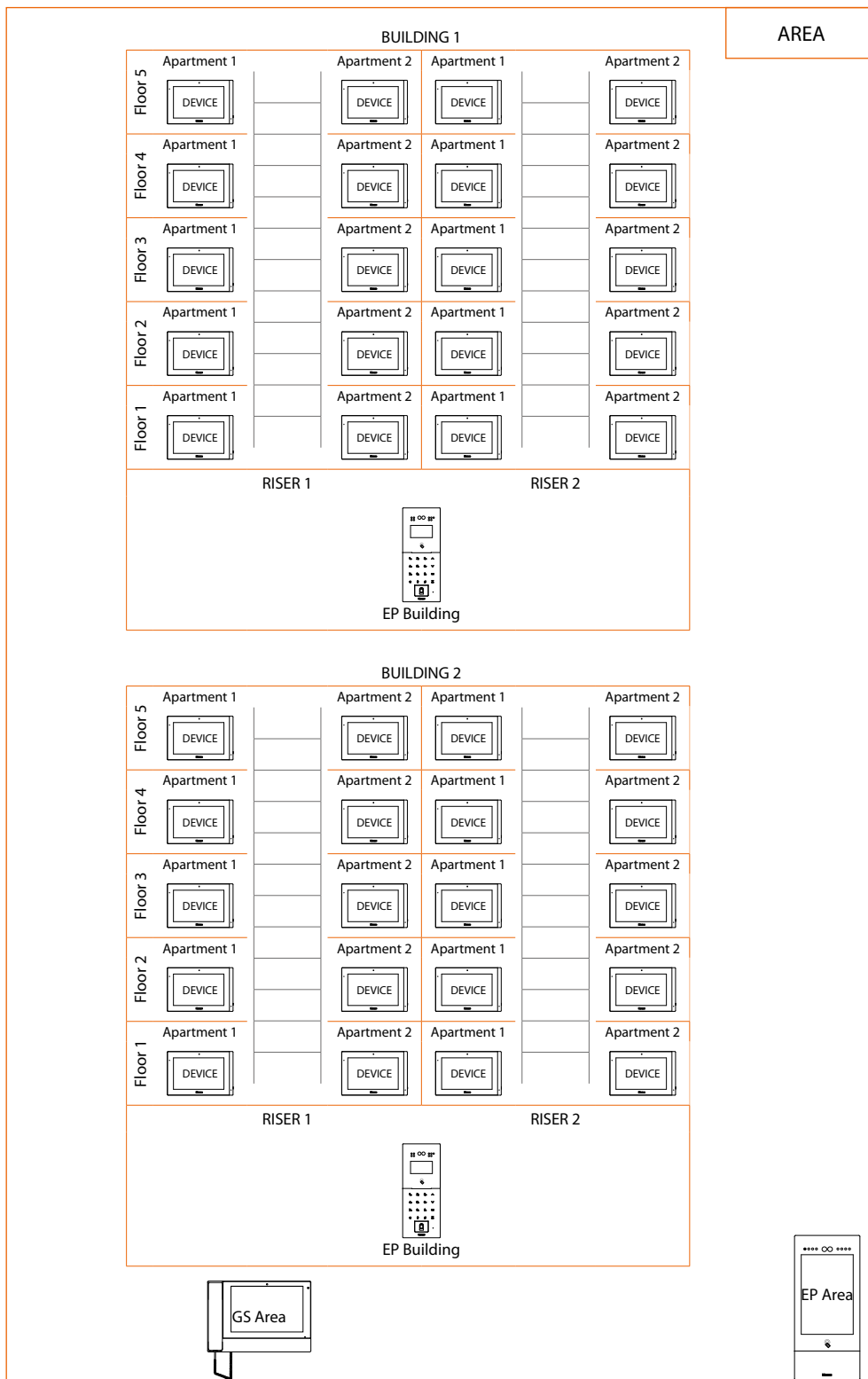

Warning: the configuration operations shown below are those required for creating the sample structure. See the Software Manual for all the other possible configurations.

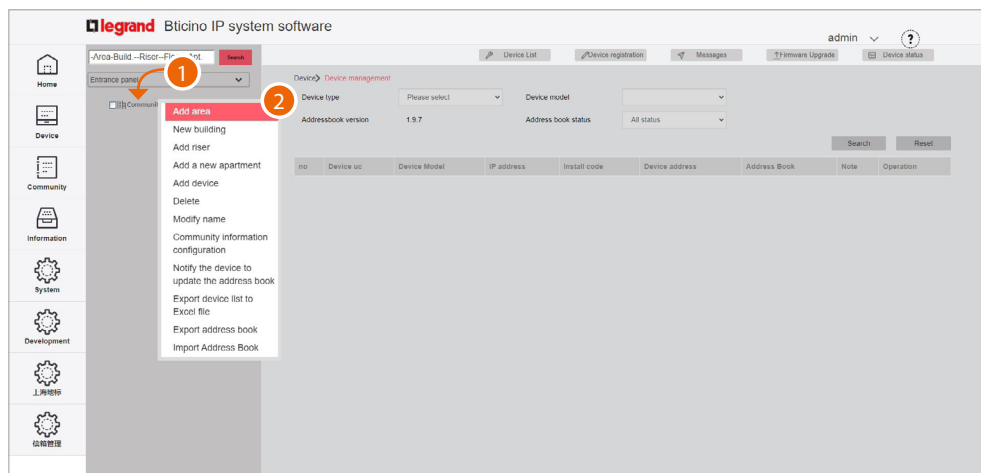

1. Click the Community with the right mouse button: a drop-down menu will appear with the commands for its configuration
2. Click to add a new Area

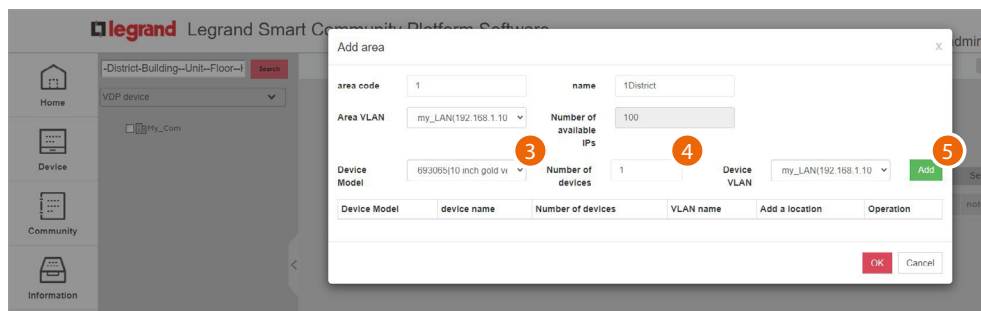
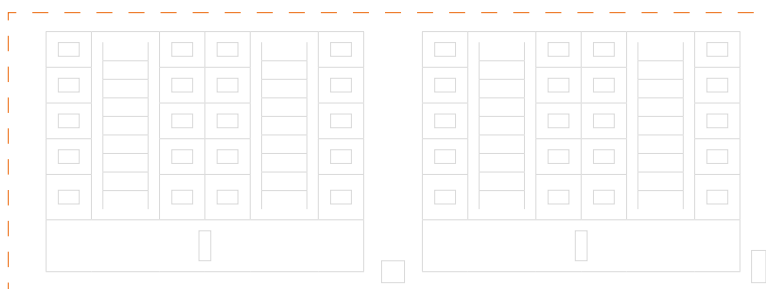

3. Select the Area device (EP Area1)
4. Select the quantity
5. Click to add

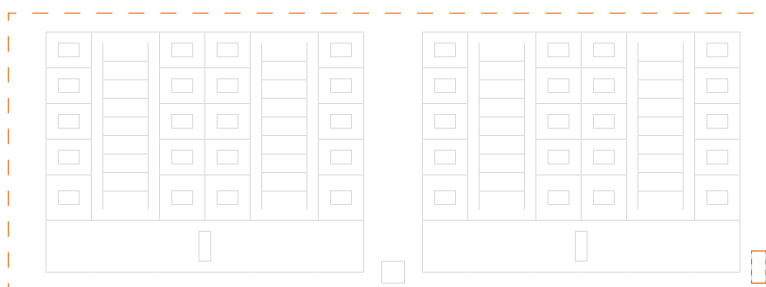

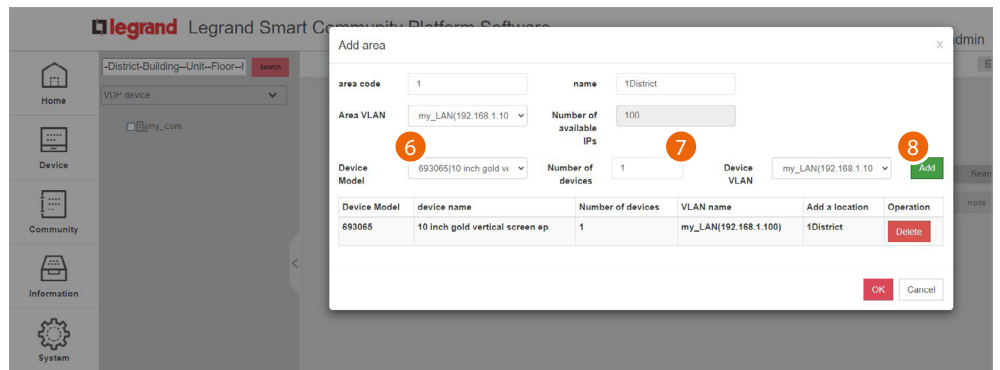

6. Select the second Area device (GS Area1)
7. Select the quantity
8. Click to add

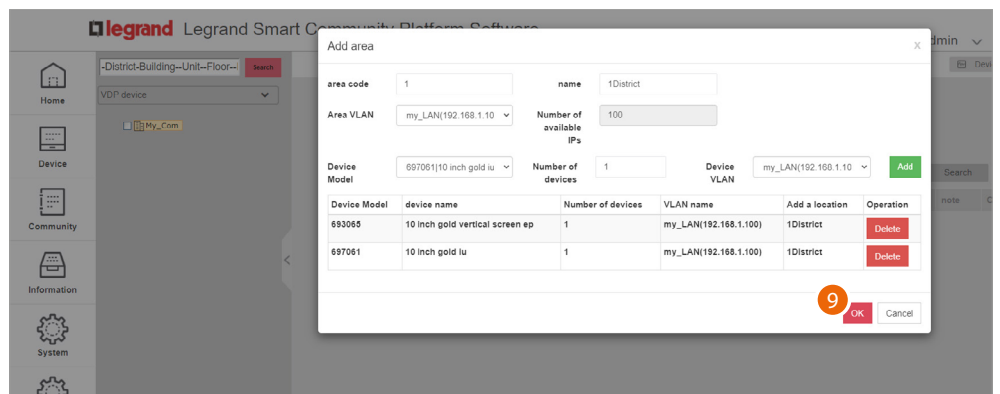
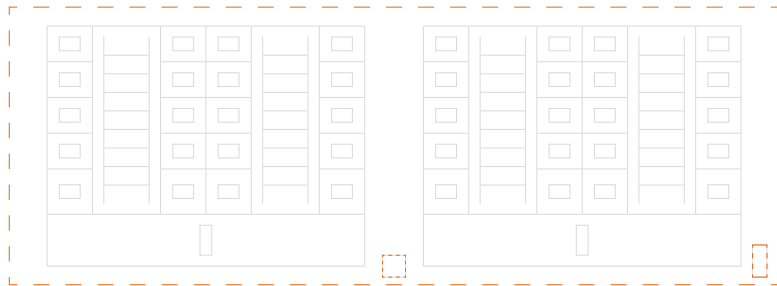

9. Click to confirm

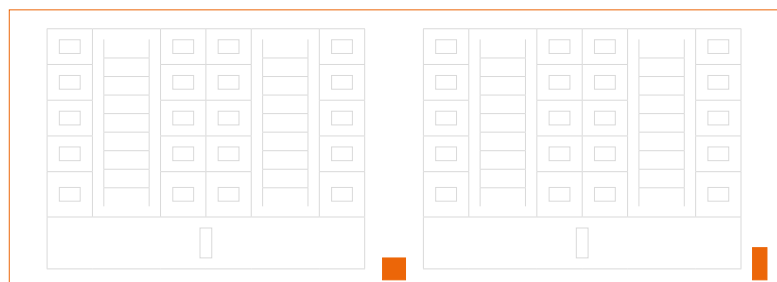

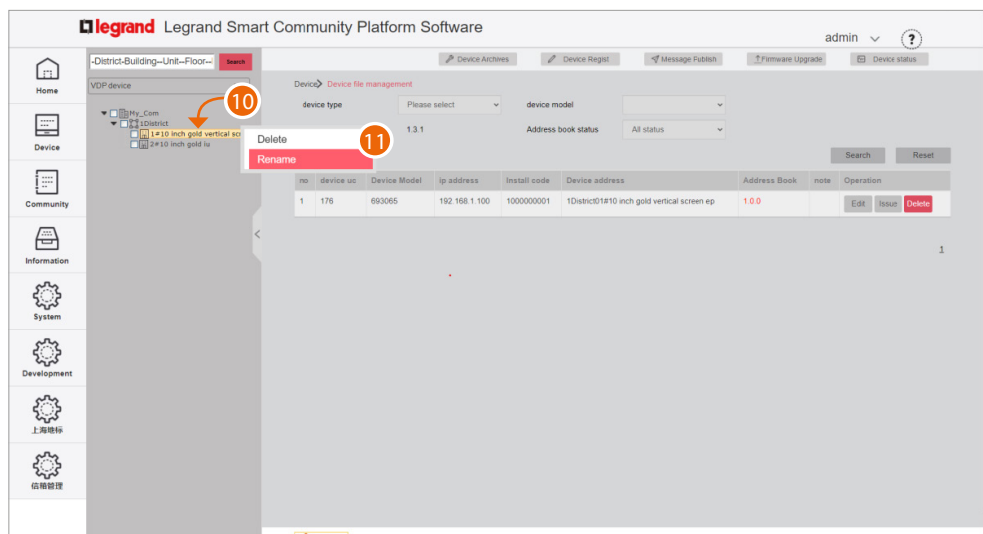

After inserting the devices, you will be able to customize their name

10. With the right mouse button click the device that you want to rename: a drop-down menu will appear

11. Click to open the edit window

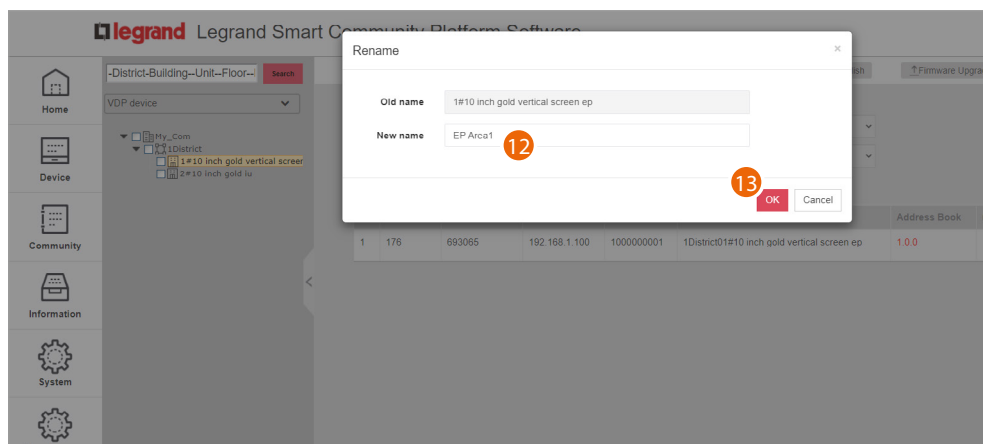

12. Enter the new name

13. Click to confirm

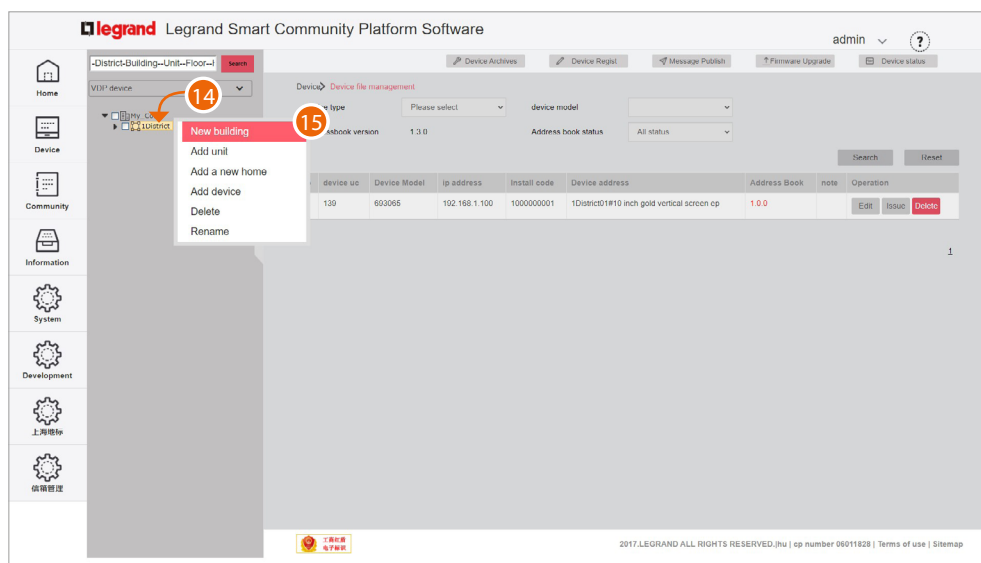

14. Click the Area with the right mouse button. This will open a drop-down menu

15. Click to add a **new Building**

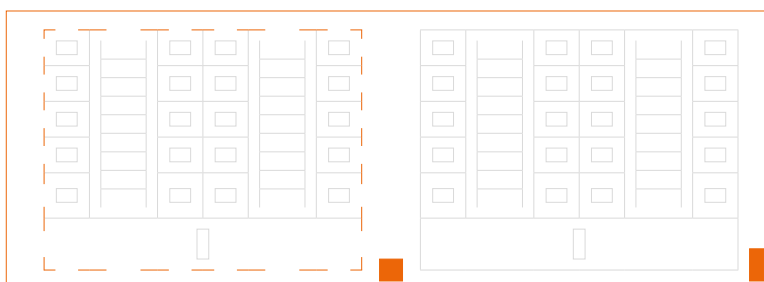

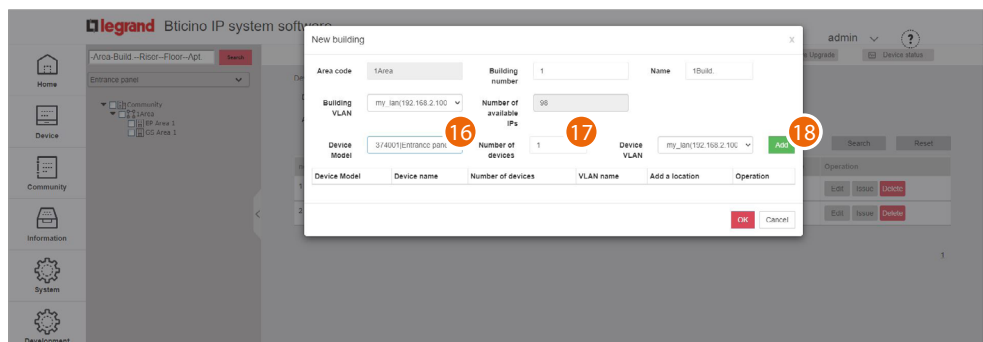

16. Select the Building device (EP Building1)

Note: the software automatically applies a filter to only show devices that are consistent with the component that you are adding

17. Select the quantity

18. Click to add

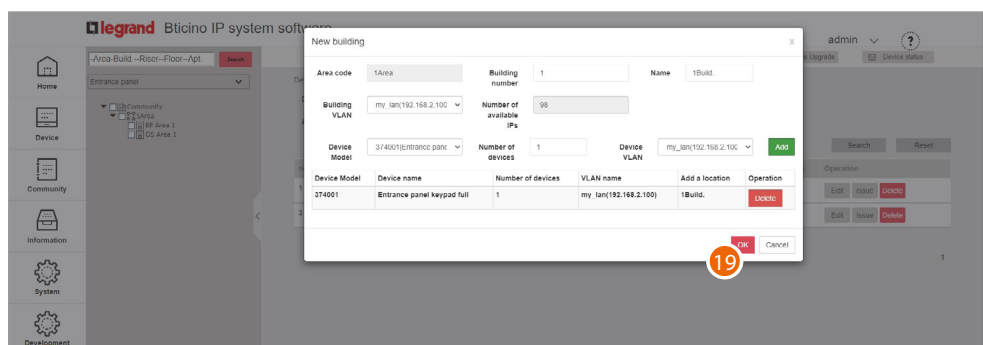
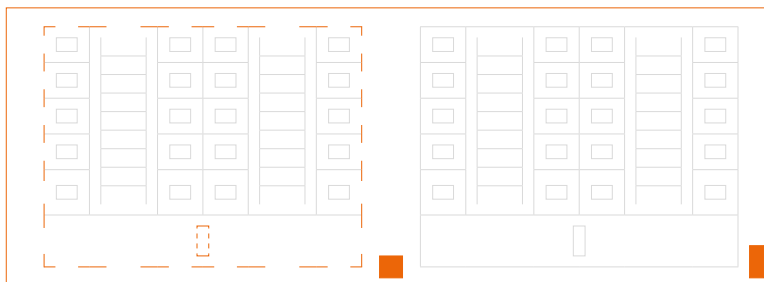

19. Click to confirm

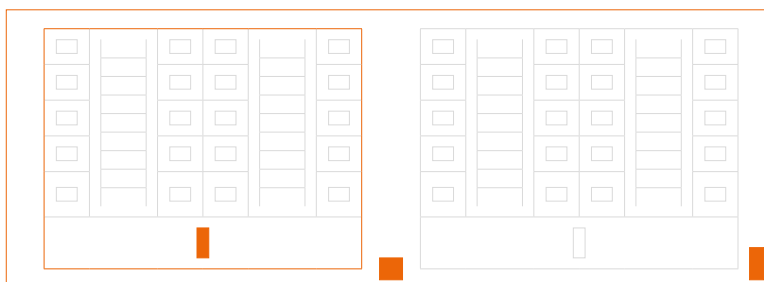

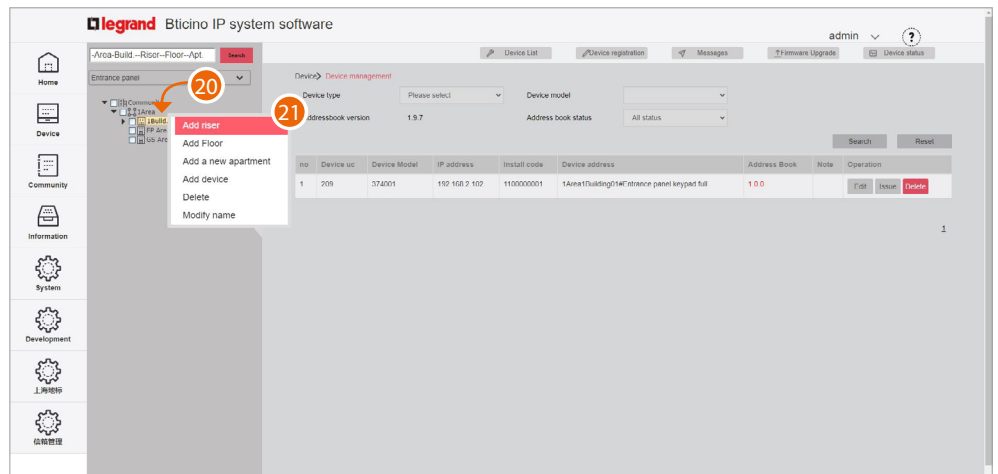

20. Click the Building with the right mouse button. This will open a drop-down menu

21. Click to add a new Riser

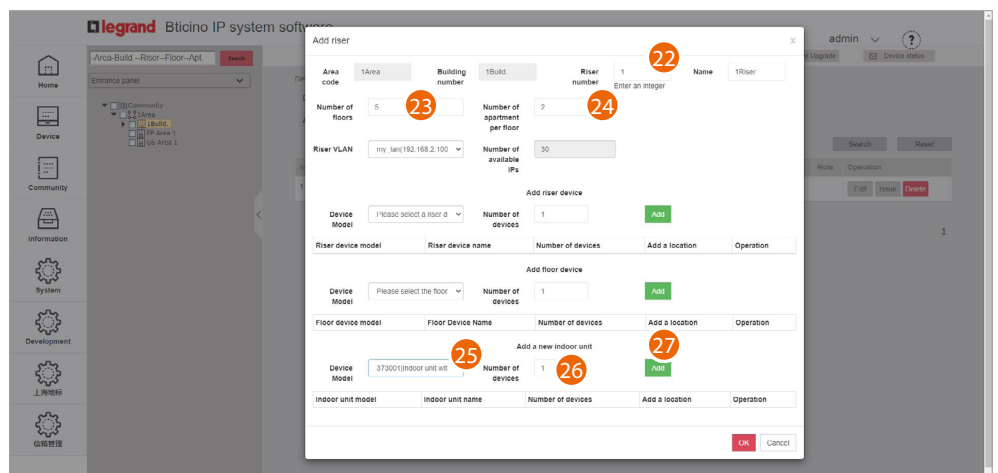
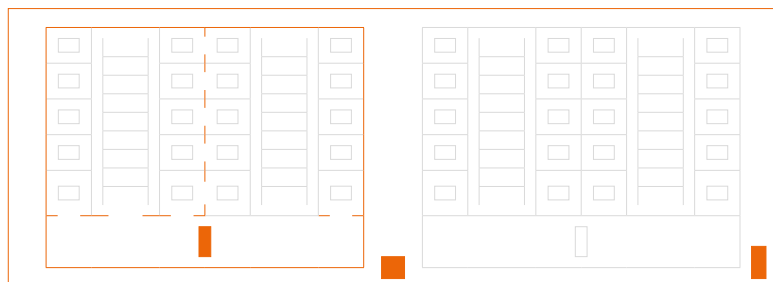

22. Enter the progressive Riser number

23. Select the number of Floors in the Building (5)

24. Select the number of Apartments for each Floor (2)

25. Select the Device Apartment

26. Select the quantity

27. Click to add

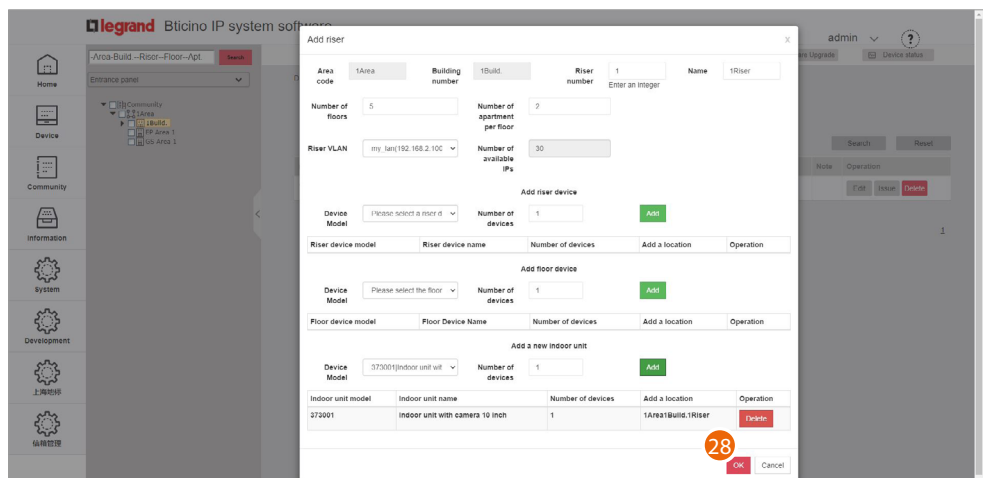

28. Click to confirm

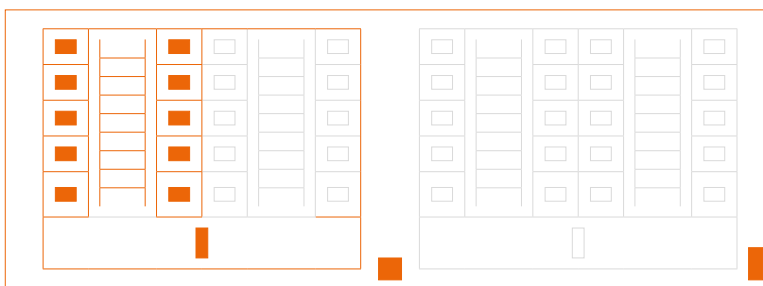

Repeat the same steps for Riser 2

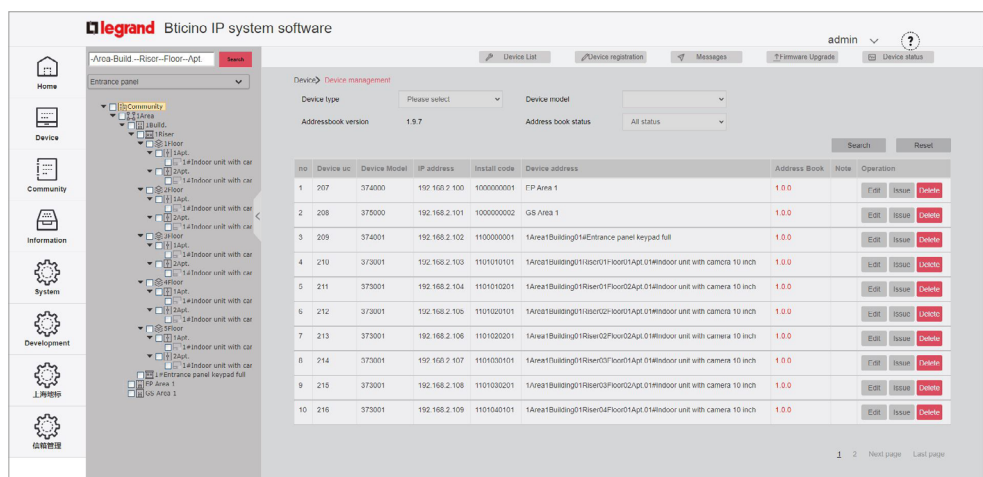

Repeat the same steps for Building 2

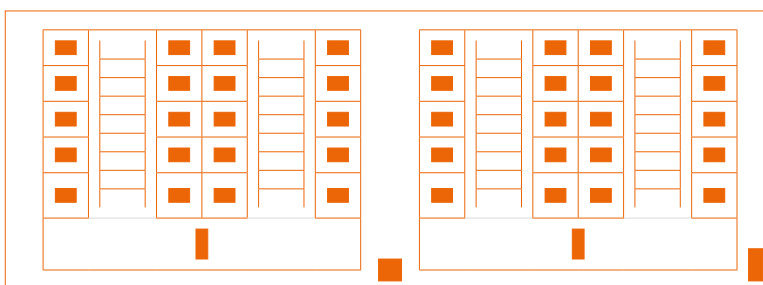

Mac address registration

Now that the structure is complete, you will need to associate the MAC addresses of the physical devices with the virtual ones included earlier in the structure.

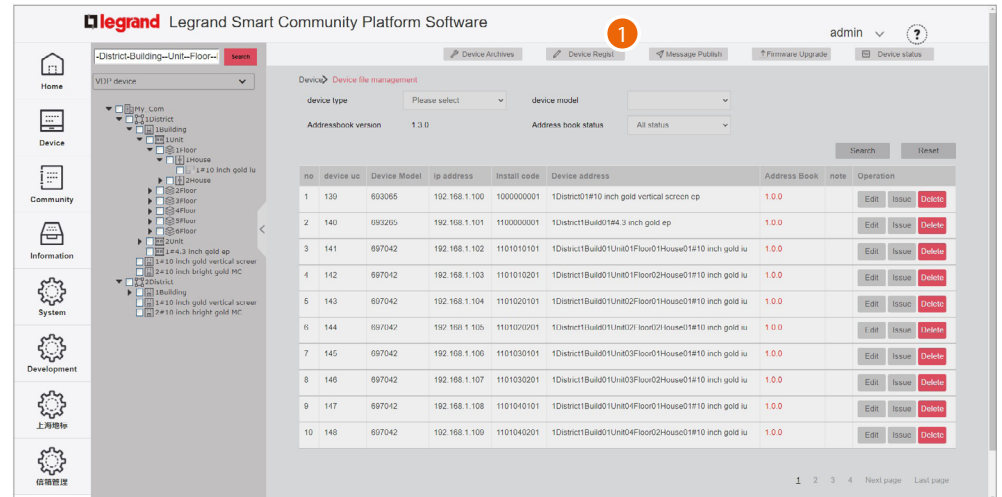

1. Click to enter the device registration section

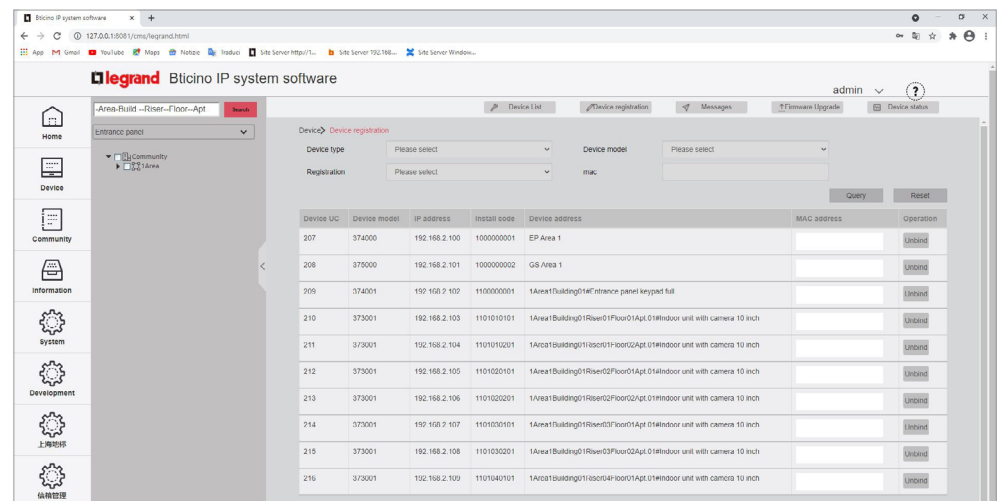

This section includes all the devices to associate. The MAC address can be entered directly from this screen

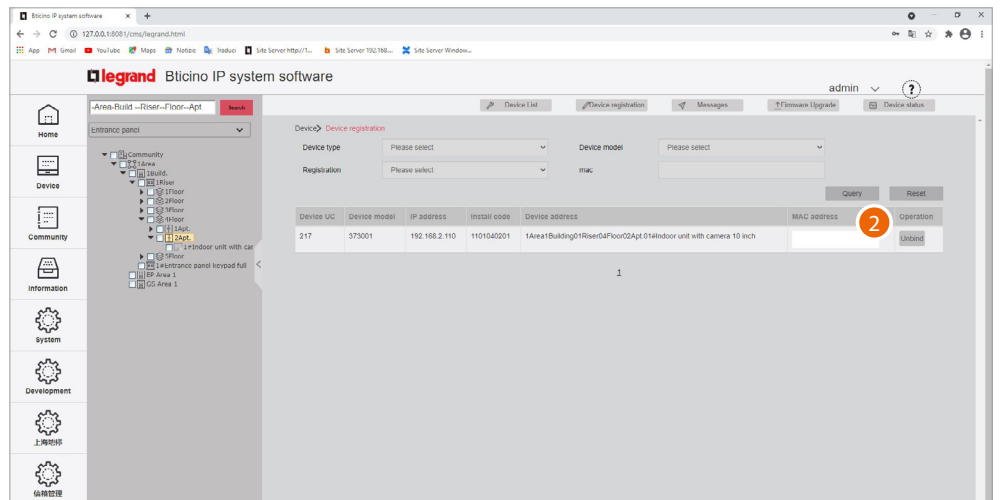

Alternatively, it is possible to select a branch and only view the devices belonging to that branch. It is also possible to select a device from the menu tree and enter the MAC address individually. The advantage of this second method, is that it is easy to identify devices based on their geographical location.

2. Move the cursor inside the field

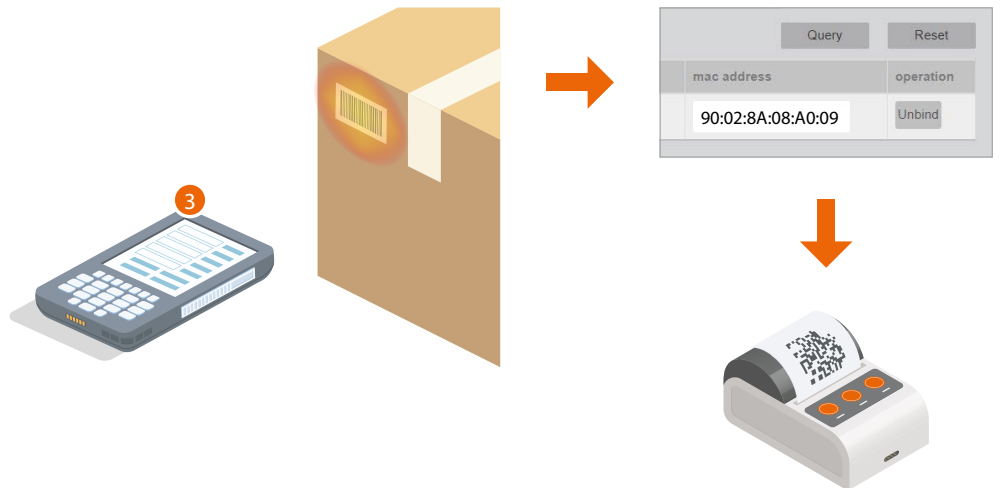

3. Read the address from the label on the packaging, or the label on the back of the device

The MAC address will appear in the field and the printer will automatically print a label that you will need to apply to the package

The printed label contains the following data:

- A Where to place the device based on the previously created structure
- B Device model
- C MAC address

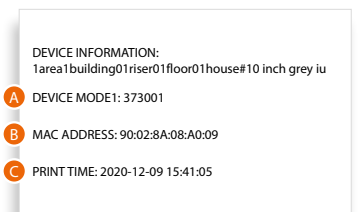

If a code reader is not available, manually enter the address (including the separation “:”).
If the printer is connected to the network and ready, the label will be printed automatically.

Repeat for all devices

Forwarding of the address book to the DES Server

After creating the structure and configuring the virtual devices, it will be necessary to forward the address book to the system, therefore “instructing” the system to use this configuration.

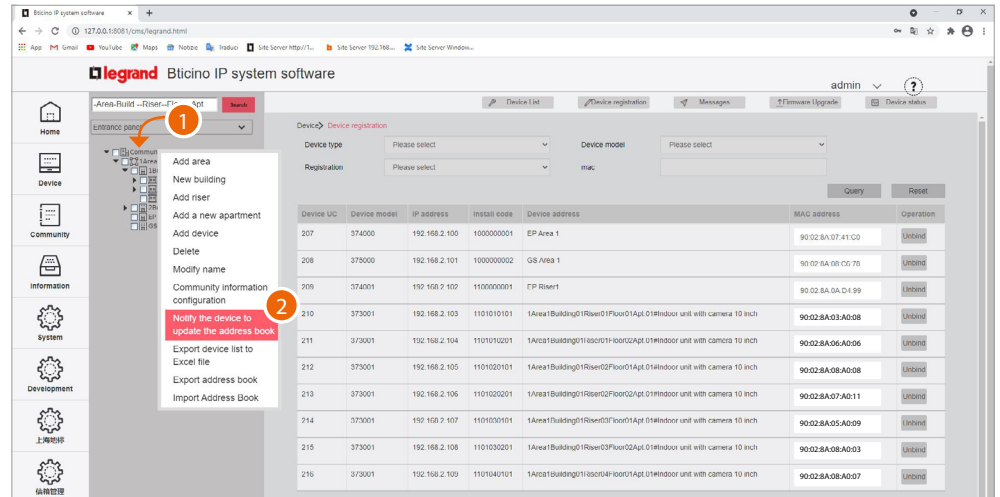

1. Click Community with the right mouse button: a drop-down menu will appear
2. Click to update the system address book

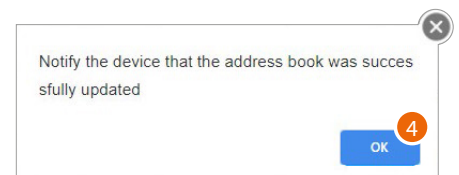
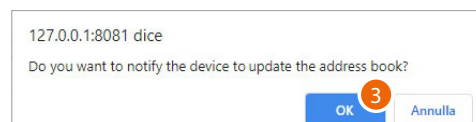

3. Click to confirm
4. Click to finish

The address book is now saved in the DES Server. To avoid accidental loss, it is also possible to save it in an archive file.

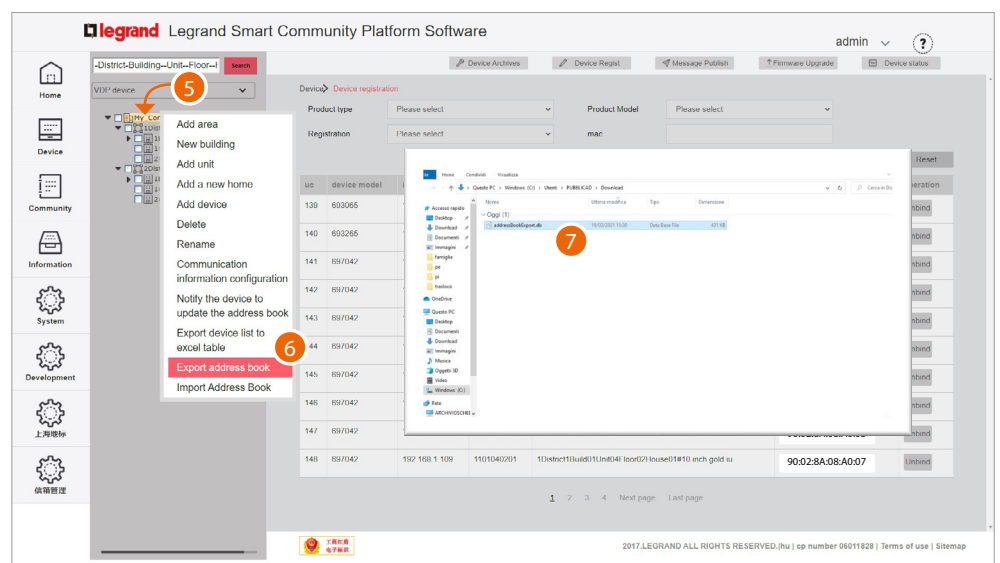

5. Click Community with the right mouse button: a drop-down menu will appear
6. Click to export the address book to a file
7. The file will be saved in the download folder of your computer

Installation of the devices

To transfer the configuration to the devices, these must be installed and powered

Switch off the power supply to the system and check that there is no voltage

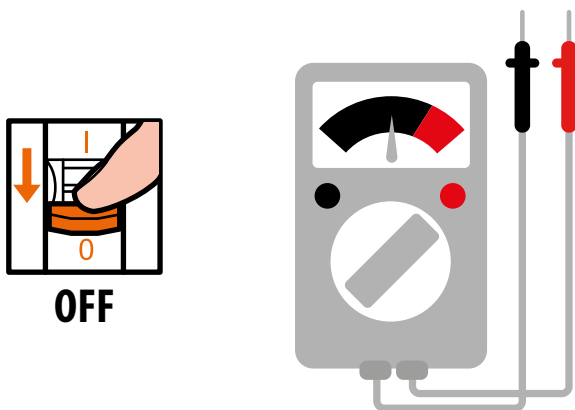

Install the devices

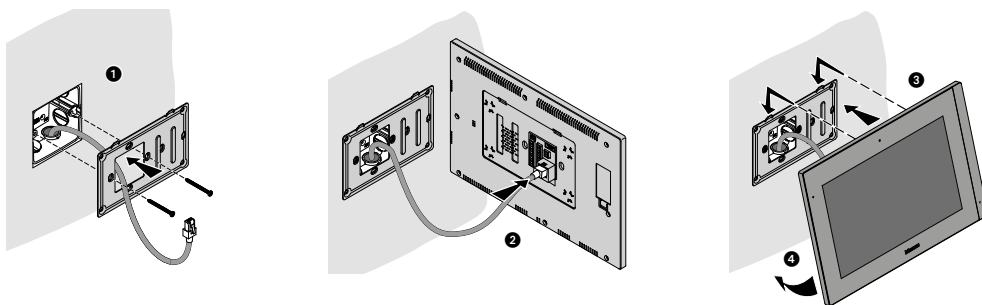

 The RJ45 cable must be at least 200 mm long

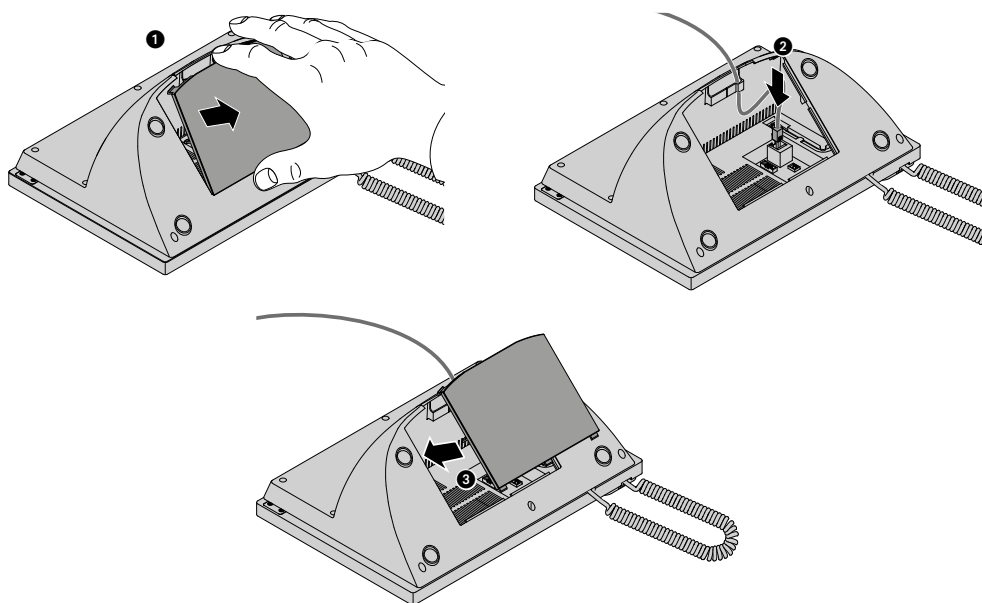



The RJ45 cable must be at least 200 mm long

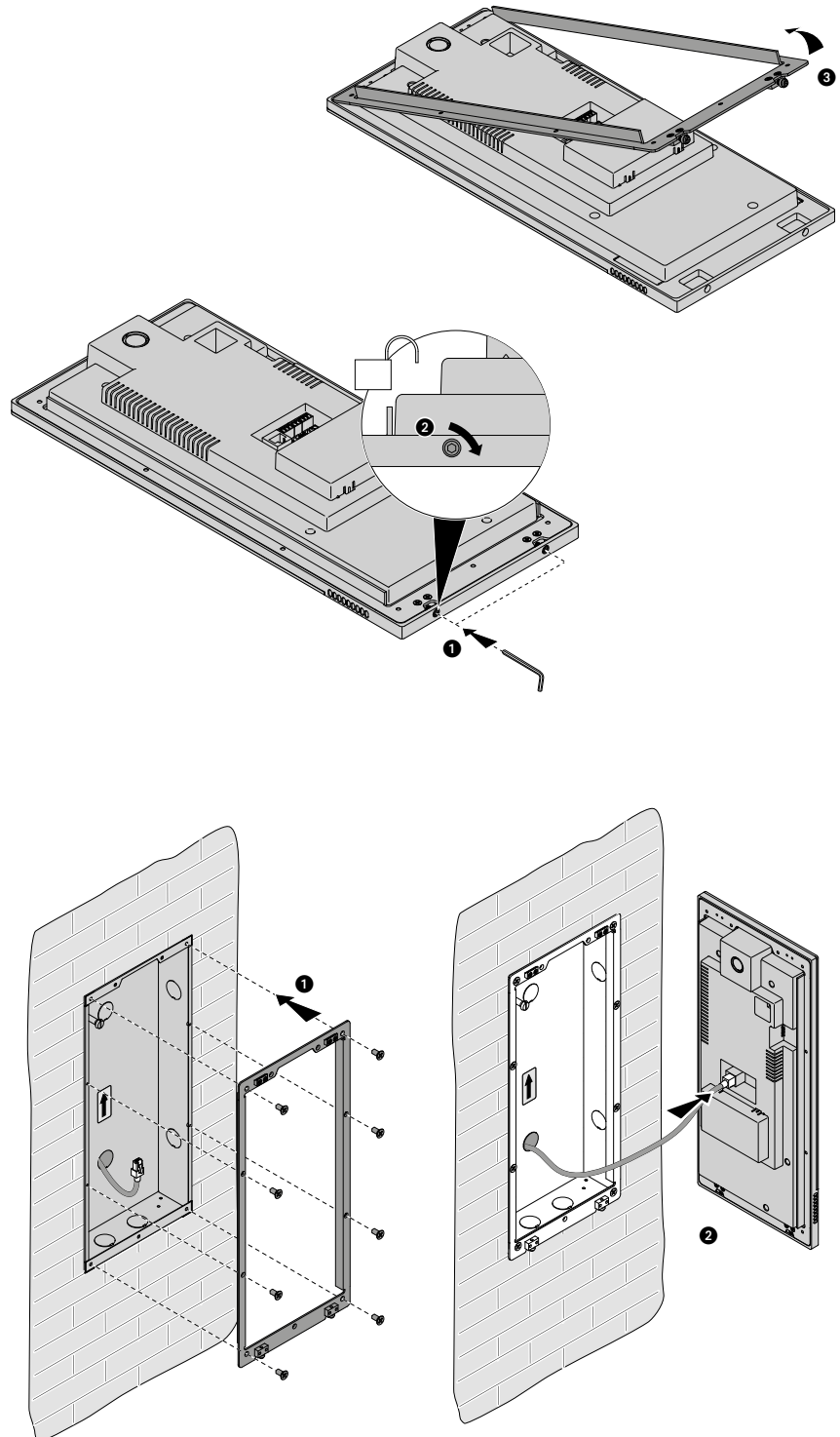

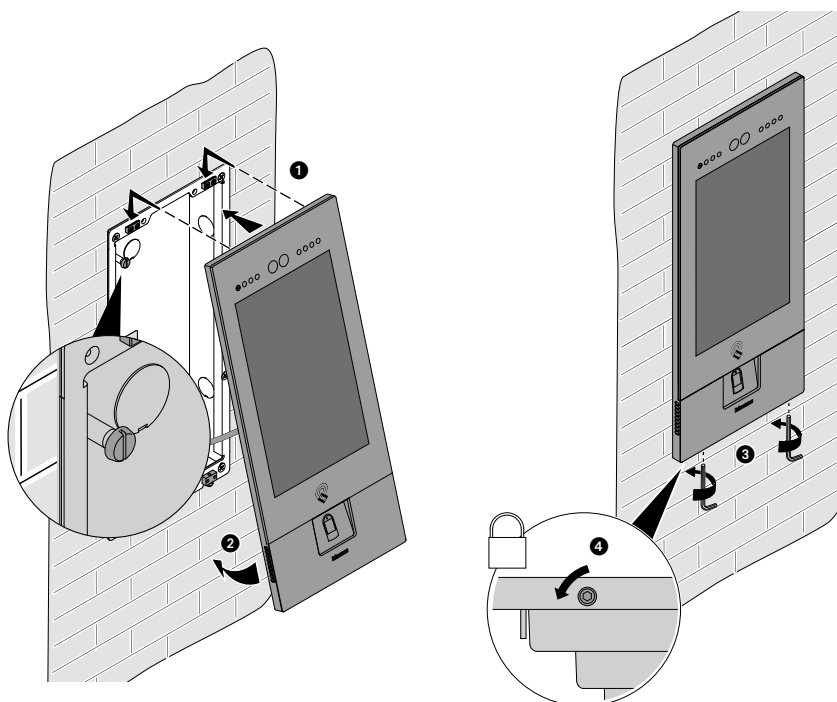

Warning: please note that the EP installation shown is representative of all EPs.
For more details, see the specific instructions in the package

Reconnect the power supply

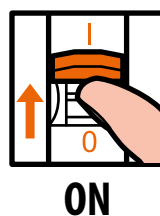

Activation of the devices

Thanks to the previously entered MAC address, once powered, the device checks that a configuration (address book) is available on the DES Server, and if so acquires it.

Note: devices that were already configured in the past must be reset.
After rebooting, they will configure themselves

System test

It is now possible to test the system, for example by making a call from the EP

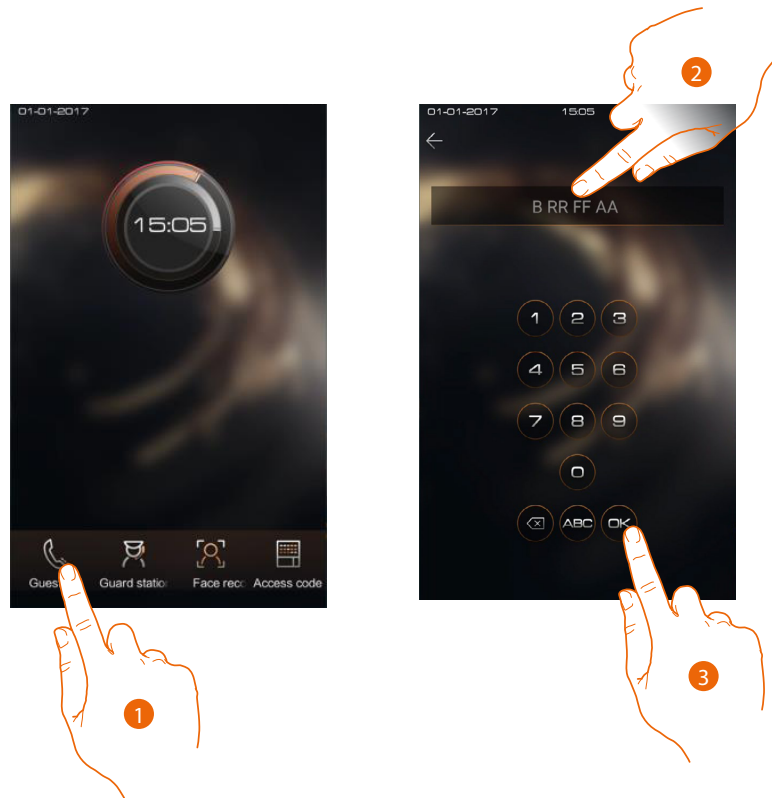

1. Touch to make the call
2. Enter the IU address

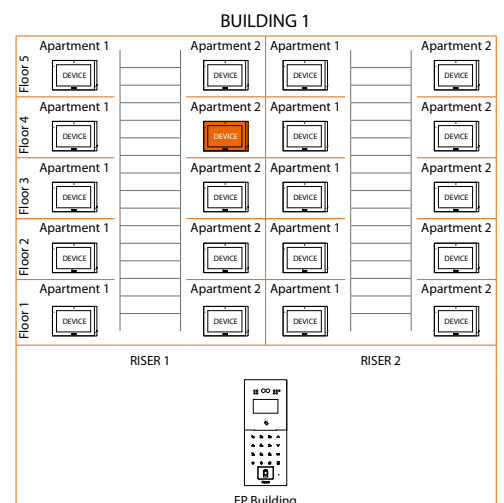

3. Touch to send the call

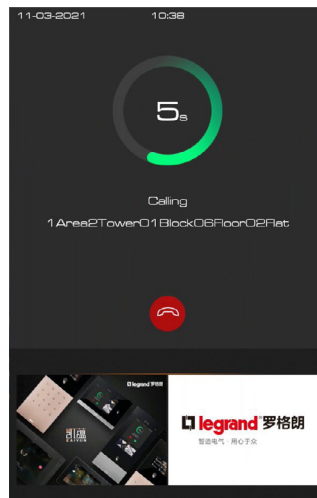

the call is in progress

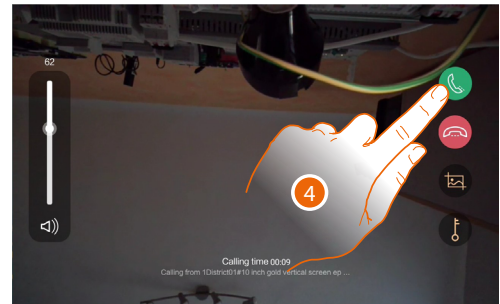

4. Reply from the IU

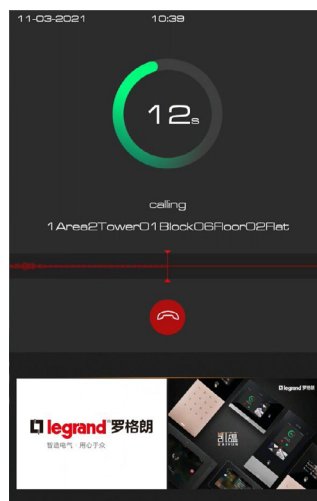

Test the audio signal on the EP

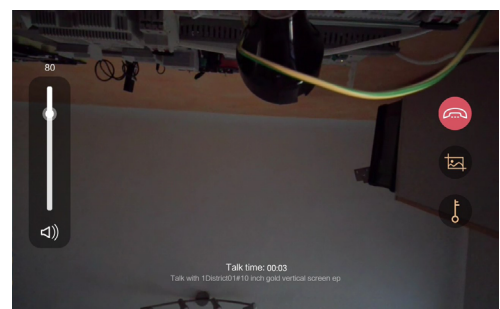

Test the audio/video signal on the IU

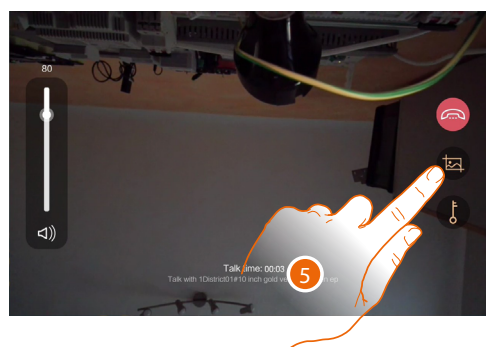

5. Tap to capture an image of the screen

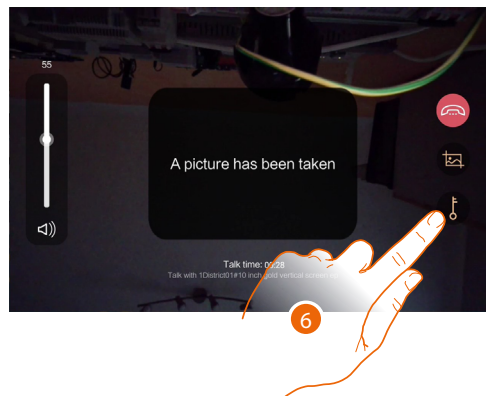

A confirmation message appears.

6. Touch to open the EP door lock

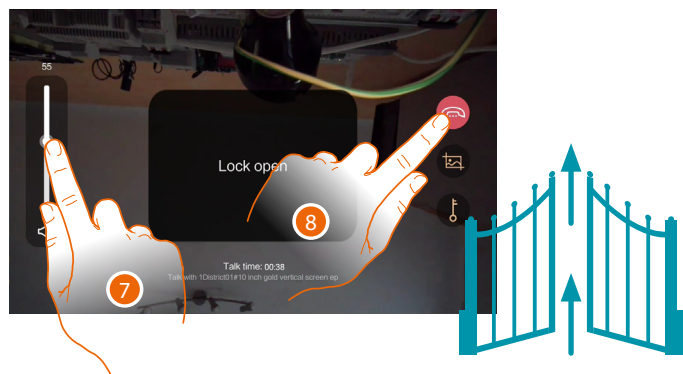

A confirmation message appears

7. Tap to adjust the volume
8. Touch to end the call

BTicino SpA
Viale Borri, 231
21100 Varese
www.bticino.com
